



Benennung:

Mess-Winkelstück
mit Abhebekraft
indicator angular attachment with lifting force

Zeichnungs-Nr.:

8822 ZA

Sachnummer: 8822ZA

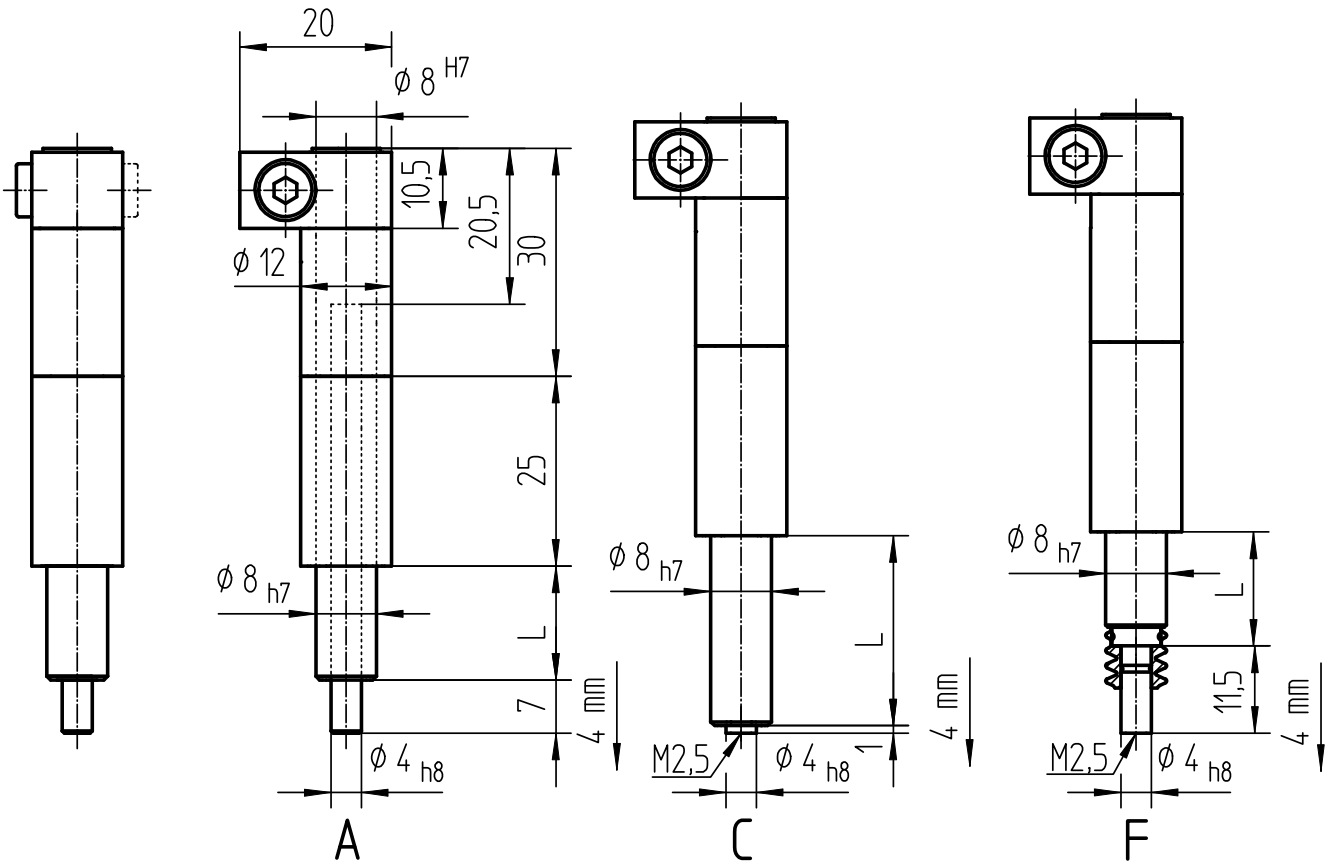

L
15
25
50
75
100
125
150
200
230

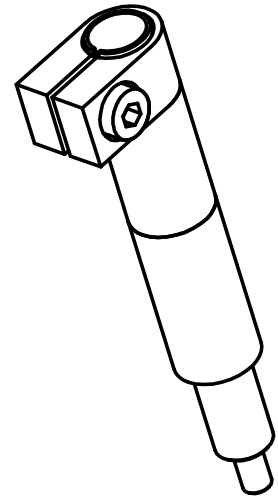
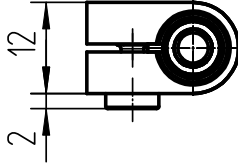

Bezeichnung:
designation:

Mess-Winkelstück 8822 A 15

Länge L
length L

Ausführung
version

Typ-Nr.
type no.

Benennung
nomination

Copyrights by Kordt GmbH & Co KG.

Schutzvermerk nach DIN 34-1 beachten

KORDT
GERMANY

	Datum	Name	Maßstab 1:1	Allgemeintoleranzen ISO 2768-mK	Blatt 1
Bearb.	06.09.05	Jurow	Format A4 ZA	CAD OneSpace Designer	1 Bl.
Artikel-Gruppe		MNT	(Ers.f.)	(Ers.d.)	