



Benennung:

Mess-Winkelstück
mit Abhebekraft
indicator angular attachment with lifting force

Zeichnungs-Nr.:

8803 ZA

Sachnummer: 8803ZA

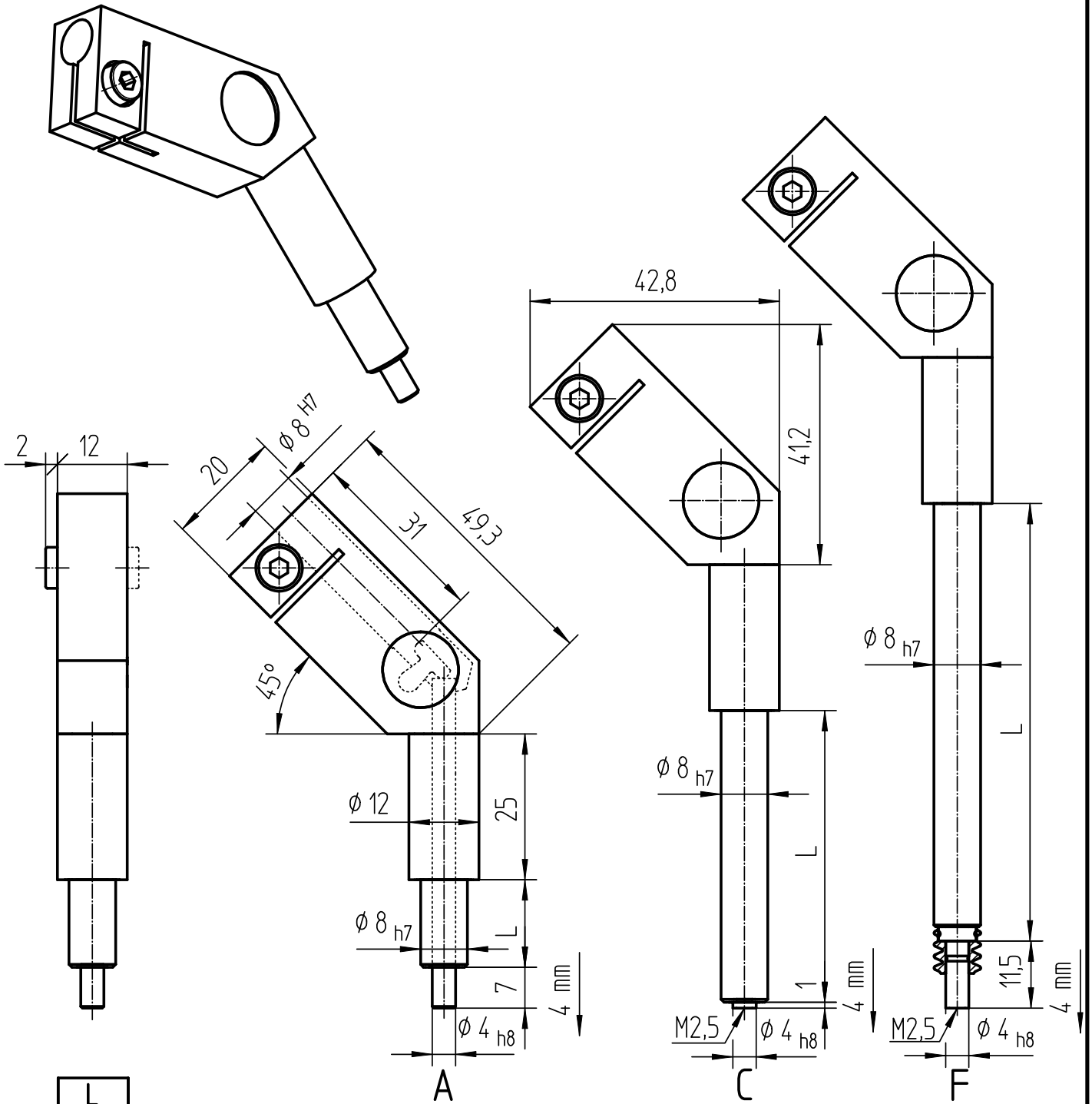

L
15
25
50
75
100
125
150
200
230

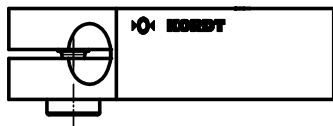

Bezeichnung:
designation:

Mess-Winkelstück 8803 A 15

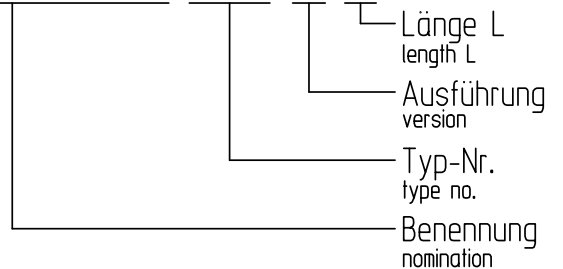

Copyrights by Kordt GmbH & Co KG.

Schutzvermerk nach DIN 34-1 beachten

KORDT
GERMANY

	Datum	Name	Maßstab 1:1	Allgemeintoleranzen ISO 2768-mK	Blatt 1
Bearb.	27.07.05	Jurow	Format A4 ZA	CAD OneSpace Designer	1 Bl.
Artikel-Gruppe		MNT	(Ers.f.)	(Ers.d.)	