



Benennung:

Messuhrhalter

dial gauge holders

Zeichnungs-Nr.:

Messuhrhalter

Sachnummer: Messuhrhalter

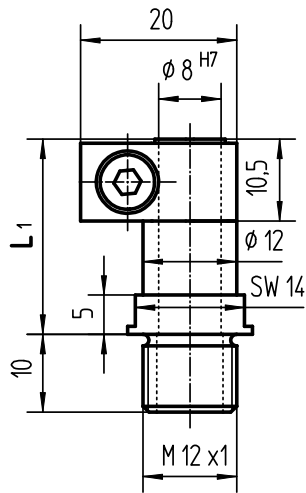

8640 L₁

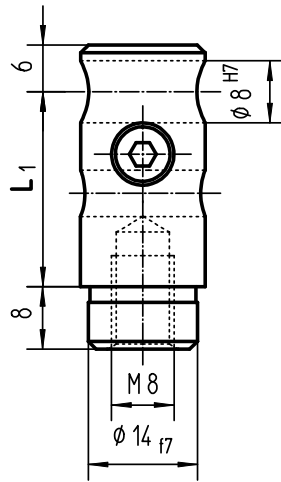

8641 L₁

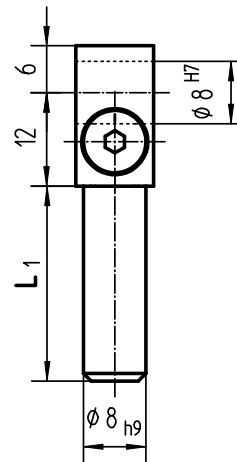

8646 L₁

L ₁
25
50
75
100
125
150
200

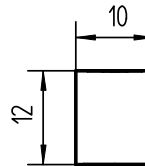
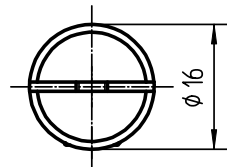
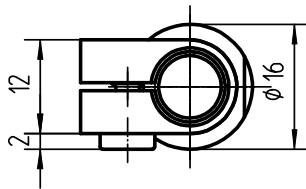

Schutzvermerk nach DIN 34-1 beachten Copyrights by Kordt GmbH & Co. KG.

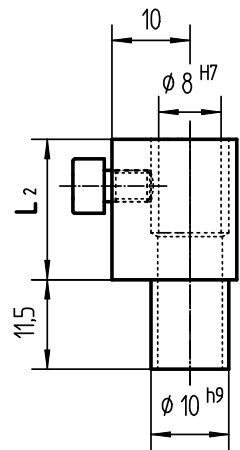

8669 L₂

L ₂
18
28

